

ACBMV B. CASADIO VIBRATION
 Z.I. Mi-Plaine
 51 Rue Ampère
 B.P. 31
 69682 CHASSIEU CEDEX (FRANCE)
 Tel.: 04 78 90 87 87 / Fax.: 04 78 90 87 88
 Email: vibrateur@orange.fr
 Internet: acbmv.com

6 POLES - 1000 RPM ATEX II 2D tD A21 IP 66 ZONE 21-22
 REF.: 602093A Dust T°=135°C
 SIZE: 95

Certifications:



MECHANICAL AND ELECTRICAL SPECIFICATIONS

Eccentric weight setup (%)	Static moment (kgmm)	Working moment (kgcm)	Centrifugal force (kg)	Centrifugal force (kN)	Estimated bearings life time (hours)
100	7752,00	1550,40	8666	85,00	18827
90	6976,80	1395,36	7799	76,50	26753
80	6201,60	1240,32	6933	68,00	39607
70	5426,40	1085,28	6066	59,50	61826
60	4651,20	930,24	5200	51,00	>100000
50	3876,00	775,20	4333	42,50	>100000
40	3100,80	620,16	3466	34,00	>100000
30	2325,60	465,12	2600	25,50	>100000
20	1550,40	310,08	1733	17,00	>100000
10	775,20	155,04	867	8,50	>100000

Power supply (volts)	400
Phases:	three phases
Frequency (Hz)	50 Hz
Rotation speed (RPM)	1000
Max input power (watt)	7500
Max current (amp)	14,00
IS/IR	4,13

DIMENSIONAL SPECIFICATIONS (mm)

Vibrator weight: 326,0 kg

Continual service ambient temperature: -20°C à +40°C - Tropicalization anti-mold - Mechanical protection: IP66 IK08 according to IEC
 Bearing type: ROLLER
 Lubrication LONG-LIFE with KLUEBER STABURAGS NBU 8EP.
 Re lubrication quantity after 1000 hours of using: 80g
 Max quantity by replaced bearing: 150g
 Fixing with 4 screws M27 - 1" quality 8.8 with tightening torque (kgm - ft/lb): 89 - 645
 Power supply cable size: 13 à 20 mm - Cable entry thread: M32x1,5
 Maintenance space: 255 mm

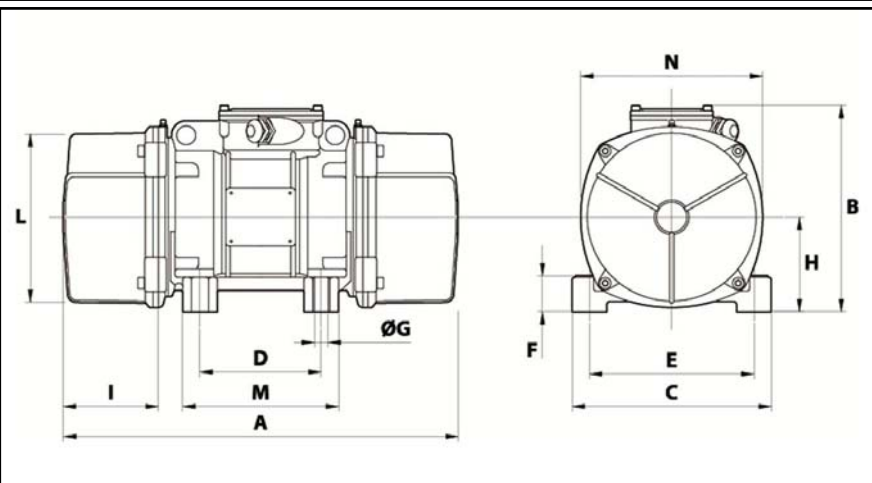

A	870
B	395
C	392
D	200
E	320
F	100
G	28
N° HOLES	4
H	192
I	255
L	355
M	270
N	375