

ACBMV B. CASADIO VIBRATION
 Z.I. Mi-Plaine
 51 Rue Ampère
 B.P. 31
 69682 CHASSIEU CEDEX (FRANCE)
 Tel.: 04 78 90 87 87 / Fax.: 04 78 90 87 88
 Email: vibrateur@orange.fr
 Internet: acbmv.com

6 POLES - 1000 RPM ATEX II 2D tD A21 IP 66 ZONE 21-22
 REF.: 602134A Dust T°=135°C
 SIZE: 100

Certifications:



MECHANICAL AND ELECTRICAL SPECIFICATIONS

Eccentric weight setup (%)	Static moment (kgmm)	Working moment (kgcm)	Centrifugal force (kg)	Centrifugal force (kN)	Estimated bearings life time (hours)
100	10996,00	2199,20	12294	119,00	21318
90	9896,40	1979,28	11065	107,10	30284
80	8796,80	1759,36	9835	95,20	44855
70	7697,20	1539,44	8606	83,30	69993
60	6597,60	1319,52	7376	71,40	>100000
50	5498,00	1099,60	6147	59,50	>100000
40	4398,40	879,68	4918	47,60	>100000
30	3298,80	659,76	3688	35,70	>100000
20	2199,20	439,84	2459	23,80	>100000
10	1099,60	219,92	1229	11,90	>100000

Power supply (volts)	400
Phases:	three phases
Frequency (Hz)	50 Hz
Rotation speed (RPM)	1000
Max input power (watt)	9000
Max current (amp)	16,30
IS/IR	5,21

DIMENSIONAL SPECIFICATIONS (mm)

Vibrator weight: 500,0 kg

Continual service ambient temperature: -20°C à +40°C - Tropicalization anti-mold - Mechanical protection: IP66 IK08 according to IEC

Bearing type: ROLLER

Lubrication LONG-LIFE with KLUEBER STABURAGS NBU 8EP.

Re lubrication quantity after 1000 hours of using: 130g

Max quantity by replaced bearing: 260g

Fixing with 6 screws M42 - 1 5/8" quality 8.8 with tightening torque (kgm - ft/lb): 290 - 2090

Power supply cable size: 13 à 20 mm - Cable entry thread: M32x1,5

Maintenance space: 240 mm

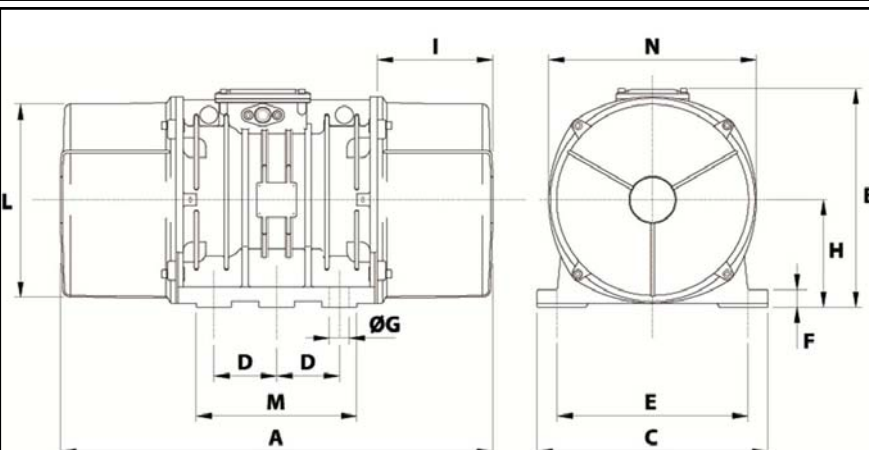

A	990
B	454
C	530
D	140
E	440
F	38
G	45
N° HOLES	6
H	230
I	240
L	423
M	370
N	448