

ACBMV B. CASADIO VIBRATION
 Z.I. Mi-Plaine
 51 Rue Ampère
 B.P. 31
 69682 CHASSIEU CEDEX (FRANCE)
 Tel.: 04 78 90 87 87 / Fax.: 04 78 90 87 88
 Email: vibrateur@orange.fr
 Internet: acbmv.com

6 POLES - 1000 RPM ATEX II 2D tD A21 IP 66 ZONE 21-22
 REF.: 602136A Dust T°=135°C
 SIZE: 97

Certifications:



MECHANICAL AND ELECTRICAL SPECIFICATIONS

Eccentric weight setup (%)	Static moment (kgmm)	Working moment (kgcm)	Centrifugal force (kg)	Centrifugal force (kN)	Estimated bearings life time (hours)
100	6083,00	1216,60	6799	66,70	23188
90	5474,70	1094,94	6119	60,03	32947
80	4866,40	973,28	5439	53,36	48792
70	4258,10	851,62	4759	46,69	76154
60	3649,80	729,96	4079	40,02	>100000
50	3041,50	608,30	3400	33,35	>100000
40	2433,20	486,64	2720	26,68	>100000
30	1824,90	364,98	2040	20,01	>100000
20	1216,60	243,32	1360	13,34	>100000
10	608,30	121,66	680	6,67	>100000

Power supply (volts)	400
Phases:	three phases
Frequency (Hz)	50 Hz
Rotation speed (RPM)	1000
Max input power (watt)	5000
Max current (amp)	10,00
IS/IR	5,61

DIMENSIONAL SPECIFICATIONS (mm)

Vibrator weight: 285,0 kg

Continual service ambient temperature: -20°C à +40°C - Tropicalization anti-mold - Mechanical protection: IP66 IK08 according to IEC

Bearing type: ROLLER

Lubrication LONG-LIFE with KLUEBER STABURAGS NBU 8EP.

Re lubrication quantity after 1000 hours of using: 60g

Max quantity by replaced bearing: 120g

Fixing with 6 screws M36 - 1 3/8" quality 8.8 with tightening torque (kgm - ft/lb): 190 - 1370

Power supply cable size: 13 à 20 mm - Cable entry thread: M32x1,5

Maintenance space: 174 mm

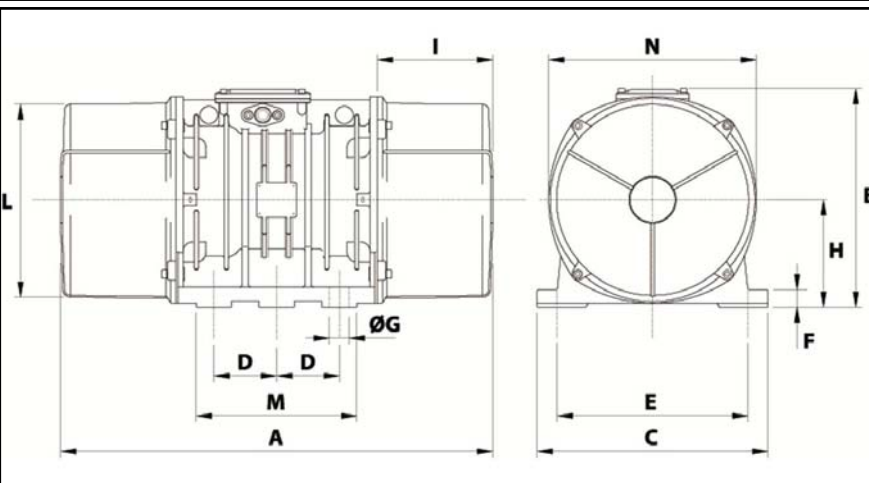

A	750
B	437
C	460
D	125
E	380
F	35
G	39
N° HOLES	6
H	215
I	174
L	387
M	320
N	414