

ACBMV B. CASADIO VIBRATION
 Z.I. Mi-Plaine
 51 Rue Ampère
 B.P. 31
 69682 CHASSIEU CEDEX (FRANCE)
 Tel.: 04 78 90 87 87 / Fax.: 04 78 90 87 88
 Email: vibrateur@orange.fr
 Internet: acbmv.com

6 POLES - 1000 RPM ATEX II 2D tD A21 IP 66 ZONE 21-22
 REF.: 602137A Dust T°=135°C
 SIZE: 97

Certifications:



MECHANICAL AND ELECTRICAL SPECIFICATIONS

Eccentric weight setup (%)	Static moment (kgmm)	Working moment (kgcm)	Centrifugal force (kg)	Centrifugal force (kN)	Estimated bearings life time (hours)
100	8673,00	1734,60	9695	95,10	17731
90	7805,70	1561,14	8726	85,59	25187
80	6938,40	1387,68	7756	76,08	37305
70	6071,10	1214,22	6787	66,57	58206
60	5203,80	1040,76	5817	57,06	97326
50	4336,50	867,30	4848	47,55	>100000
40	3469,20	693,84	3878	38,04	>100000
30	2601,90	520,38	2909	28,53	>100000
20	1734,60	346,92	1939	19,02	>100000
10	867,30	173,46	970	9,51	>100000

Power supply (volts)	400
Phases:	three phases
Frequency (Hz)	50 Hz
Rotation speed (RPM)	1000
Max input power (watt)	7600
Max current (amp)	13,50
IS/IR	4,72

DIMENSIONAL SPECIFICATIONS (mm)

Vibrator weight: 381,0 kg

Continual service ambient temperature: -20°C à +40°C - Tropicalization anti-mold - Mechanical protection: IP66 IK08 according to IEC

Bearing type: ROLLER

Lubrication LONG-LIFE with KLUEBER STABURAGS NBU 8EP.

Re lubrication quantity after 1000 hours of using: 90g

Max quantity by replaced bearing: 180g

Fixing with 6 screws M36 - 1 3/8" quality 8.8 with tightening torque (kgm - ft/lb): 190 - 1370

Power supply cable size: 13 à 20 mm - Cable entry thread: M32x1,5

Maintenance space: 230 mm

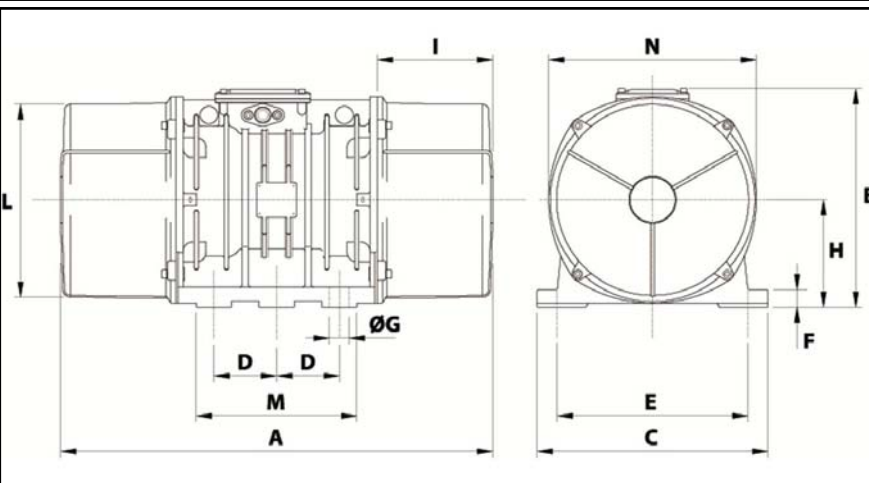

A	862
B	437
C	460
D	125
E	380
F	35
G	39
N° HOLES	6
H	215
I	230
L	387
M	320
N	414