

ACBMV B. CASADIO VIBRATION
 Z.I. Mi-Plaine
 51 Rue Ampère
 B.P. 31
 69682 CHASSIEU CEDEX (FRANCE)
 Tel.: 04 78 90 87 87 / Fax.: 04 78 90 87 88
 Email: vibrateur@orange.fr
 Internet: acbmv.com

6 POLES - 1200 RPM ATEX II 2D tD A21 IP 66 ZONE 21-22
 REF.: 602138C Dust T°=135°C
 SIZE: 90

Certifications:



MECHANICAL AND ELECTRICAL SPECIFICATIONS

Eccentric weight setup (%)	Static moment (kgmm)	Working moment (kgcm)	Centrifugal force (kg)	Centrifugal force (kN)	Estimated bearings life time (hours)
100	3288,00	657,60	5293	51,90	23822
90	2959,20	591,84	4764	46,71	33839
80	2630,40	526,08	4234	41,52	50136
70	2301,60	460,32	3705	36,33	78227
60	1972,80	394,56	3176	31,14	>100000
50	1644,00	328,80	2647	25,95	>100000
40	1315,20	263,04	2117	20,76	>100000
30	986,40	197,28	1588	15,57	>100000
20	657,60	131,52	1059	10,38	>100000
10	328,80	65,76	529	5,19	>100000

Power supply (volts)	460
Phases:	three phases
Frequency (Hz)	60 Hz
Rotation speed (RPM)	1200
Max input power (watt)	4000
Max current (amp)	6,50
IS/IR	5,08

DIMENSIONAL SPECIFICATIONS (mm)

Vibrator weight: 215,0 kg

Continual service ambient temperature: -20°C à +40°C - Tropicalization anti-mold - Mechanical protection: IP66 IK08 according to IEC

Bearing type: ROLLER

Lubrication LONG-LIFE with KLUEBER STABURAGS NBU 8EP.

Re lubrication quantity after 1000 hours of using: 50g

Max quantity by replaced bearing: 100g

Fixing with 4 screws M27 - 1" quality 8.8 with tightening torque (kgm - ft/lb): 89 - 645

Power supply cable size: 13 à 20 mm - Cable entry thread: M32x1,5

Maintenance space: 192 mm

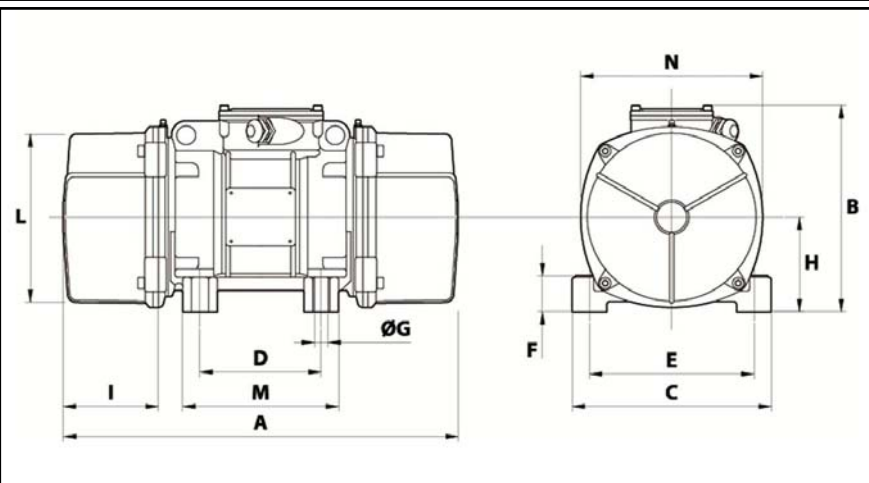

A	744
B	370
C	390
D	200
E	320
F	90
G	28
N° HOLES	4
H	180
I	192
L	330
M	270
N	350