

ACBMV B. CASADIO VIBRATION
 Z.I. Mi-Plaine
 51 Rue Ampère
 B.P. 31
 69682 CHASSIEU CEDEX (FRANCE)
 Tel.: 04 78 90 87 87 / Fax.: 04 78 90 87 88
 Email: vibrateur@orange.fr
 Internet: acbmv.com

6 POLES - 1000 RPM ATEX II 2D tD A21 IP 66 ZONE 21-22
 REF.: 602142A Dust T°=135°C
 SIZE: 105

Certifications:



MECHANICAL AND ELECTRICAL SPECIFICATIONS

Eccentric weight setup (%)	Static moment (kgmm)	Working moment (kgcm)	Centrifugal force (kg)	Centrifugal force (kN)	Estimated bearings life time (hours)
100	12662,00	2532,40	14155	139,00	22113
90	11395,80	2279,16	12740	125,10	31413
80	10129,60	2025,92	11324	111,20	46524
70	8863,40	1772,68	9909	97,30	72596
60	7597,20	1519,44	8493	83,40	>100000
50	6331,00	1266,20	7078	69,50	>100000
40	5064,80	1012,96	5662	55,60	>100000
30	3798,60	759,72	4247	41,70	>100000
20	2532,40	506,48	2831	27,80	>100000
10	1266,20	253,24	1416	13,90	>100000

Power supply (volts)	400
Phases:	three phases
Frequency (Hz)	50 Hz
Rotation speed (RPM)	1000
Max input power (watt)	10600
Max current (amp)	19,00
IS/IR	5,88

DIMENSIONAL SPECIFICATIONS (mm)

Vibrator weight: 643,0 kg

Continual service ambient temperature: -20°C à +40°C - Tropicalization anti-mold - Mechanical protection: IP66 IK08 according to IEC

Bearing type: ROLLER

Lubrication LONG-LIFE with KLUEBER STABURAGS NBU 8EP.

Re lubrication quantity after 1000 hours of using: 150g

Max quantity by replaced bearing: 300g

Fixing with 8 screws M42 - 1 5/8" quality 8.8 with tightening torque (kgm - ft/lb): 290 - 2090

Power supply cable size: 13 à 20 mm - Cable entry thread: M32x1,5

Maintenance space: 200 mm

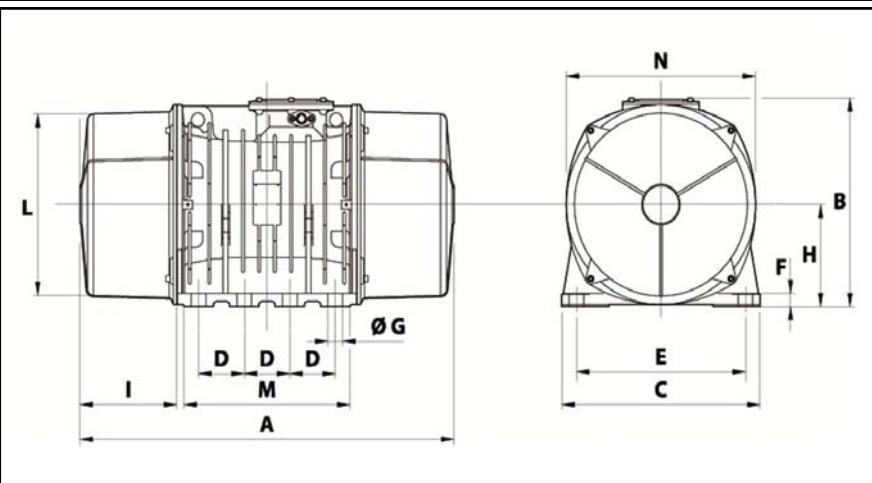

A	960
B	526
C	570
D	140
E	480
F	41
G	45
N° HOLES	8
H	268
I	200
L	486
M	510
N	516