

ACBMV B. CASADIO VIBRATION
 Z.I. Mi-Plaine
 51 Rue Ampère
 B.P. 31
 69682 CHASSIEU CEDEX (FRANCE)
 Tel.: 04 78 90 87 87 / Fax.: 04 78 90 87 88
 Email: vibrateur@orange.fr
 Internet: acbmv.com

6 POLES - 1000 RPM ATEX II 2D tD A21 IP 66 ZONE 21-22
 REF.: 602154A Dust T°=135°C
 SIZE: 80

Certifications:



MECHANICAL AND ELECTRICAL SPECIFICATIONS

Eccentric weight setup (%)	Static moment (kgmm)	Working moment (kgcm)	Centrifugal force (kg)	Centrifugal force (kN)	Estimated bearings life time (hours)
100	3422,00	684,40	3826	37,50	22531
90	3079,80	615,96	3443	33,75	32024
80	2737,60	547,52	3061	30,00	47394
70	2395,40	479,08	2678	26,25	73999
60	2053,20	410,64	2296	22,50	>100000
50	1711,00	342,20	1913	18,75	>100000
40	1368,80	273,76	1530	15,00	>100000
30	1026,60	205,32	1148	11,25	>100000
20	684,40	136,88	765	7,50	>100000
10	342,20	68,44	383	3,75	>100000

Power supply (volts)	400
Phases:	three phases
Frequency (Hz)	50 Hz
Rotation speed (RPM)	1000
Max input power (watt)	2500
Max current (amp)	5,10
IS/IR	5,91

DIMENSIONAL SPECIFICATIONS (mm)

Vibrator weight: 188,0 kg

Continual service ambient temperature: -20°C à +40°C - Tropicalization anti-mold - Mechanical protection: IP66 IK08 according to IEC

Bearing type: ROLLER

Lubrication LONG-LIFE with KLUEBER STABURAGS NBU 8EP.

Re lubrication quantity after 1000 hours of using: 30g

Max quantity by replaced bearing: 60g

Fixing with 4 screws M24 - 15/16" quality 8.8 with tightening torque (kgm - ft/lb): 71 - 513

Power supply cable size: 13 à 20 mm - Cable entry thread: M32x1,5

Maintenance space: 202 mm

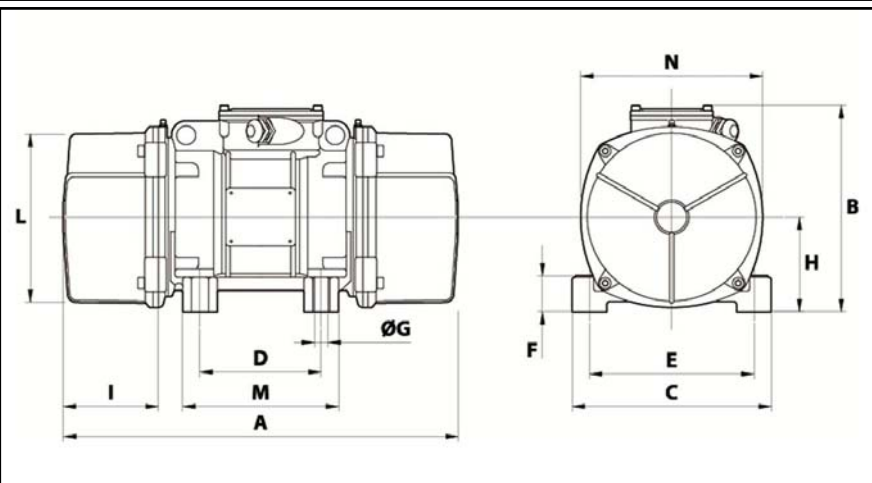

A	734
B	347
C	340
D	180
E	280
F	80
G	26
N° HOLES	4
H	165
I	202
L	303
M	240
N	320