

ACBMV B. CASADIO VIBRATION
 Z.I. Mi-Plaine
 51 Rue Ampère
 B.P. 31
 69682 CHASSIEU CEDEX (FRANCE)
 Tel.: 04 78 90 87 87 / Fax.: 04 78 90 87 88
 Email: vibrateur@orange.fr
 Internet: acbmv.com

6 POLES - 1200 RPM ATEX II 2D tD A21 IP 66 ZONE 21-22
 REF.: 602167C Dust T°=135°C
 SIZE: 70

Certifications:



MECHANICAL AND ELECTRICAL SPECIFICATIONS

Eccentric weight setup (%)	Static moment (kgmm)	Working moment (kgcm)	Centrifugal force (kg)	Centrifugal force (kN)	Estimated bearings life time (hours)
100	1720,00	344,00	2747	26,90	28887
90	1548,00	309,60	2472	24,21	41059
80	1376,00	275,20	2198	21,52	60740
70	1204,00	240,80	1923	18,83	94835
60	1032,00	206,40	1648	16,14	>100000
50	860,00	172,00	1374	13,45	>100000
40	688,00	137,60	1099	10,76	>100000
30	516,00	103,20	824	8,07	>100000
20	344,00	68,80	549	5,38	>100000
10	172,00	34,40	275	2,69	>100000

Power supply (volts)	460
Phases:	three phases
Frequency (Hz)	60 Hz
Rotation speed (RPM)	1200
Max input power (watt)	2100
Max current (amp)	3,75
IS/IR	5,60

DIMENSIONAL SPECIFICATIONS (mm)

Vibrator weight: 116,0 kg

Continual service ambient temperature: -20°C à +40°C - Tropicalization anti-mold - Mechanical protection: IP66 IK08 according to IEC

Bearing type: ROLLER

Lubrication LONG-LIFE with KLUEBER STABURAGS NBU 8EP.

Re lubrication quantity after 1000 hours of using: 18g

Max quantity by replaced bearing: 32g

Fixing with 4 screws M22 - 7/8" quality 8.8 with tightening torque (kgm - ft/lb): 56 - 411

Power supply cable size: 9 à 16 mm - Cable entry thread: M25x1,5

Maintenance space: 178 mm

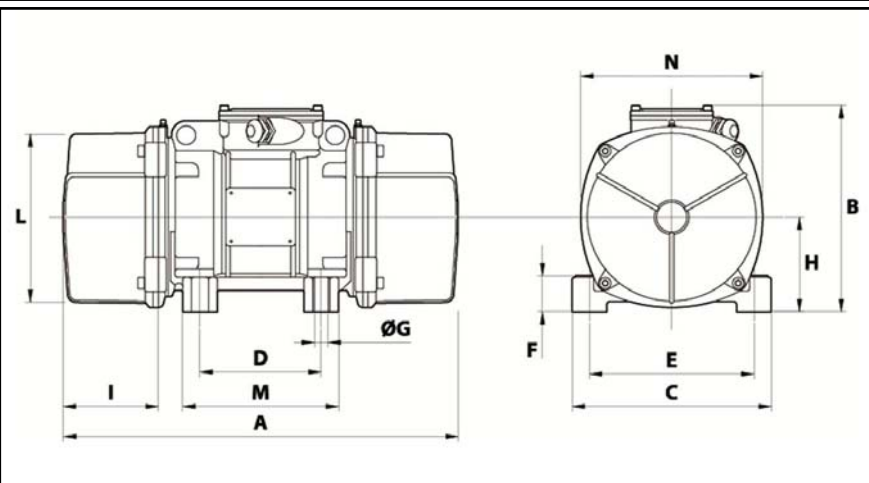

A	666
B	321
C	310
D	155
E	255
F	77
G	24
N° HOLES	4
H	157
I	178
L	277
M	215
N	295