

ACBMV B. CASADIO VIBRATION
 Z.I. Mi-Plaine
 51 Rue Ampère
 B.P. 31
 69682 CHASSIEU CEDEX (FRANCE)
 Tel.: 04 78 90 87 87 / Fax.: 04 78 90 87 88
 Email: vibrateur@orange.fr
 Internet: acbmv.com

6 POLES - 1000 RPM ATEX II 2D tD A21 IP 66 ZONE 21-22
 REF.: 602204A Dust T°=135°C
 SIZE: 80

Certifications:



MECHANICAL AND ELECTRICAL SPECIFICATIONS

Eccentric weight setup (%)	Static moment (kgmm)	Working moment (kgcm)	Centrifugal force (kg)	Centrifugal force (kN)	Estimated bearings life time (hours)
100	4206,00	841,20	4701	46,10	30408
90	3785,40	757,08	4231	41,49	43199
80	3364,80	672,96	3761	36,88	63965
70	2944,20	588,84	3291	32,27	99815
60	2523,60	504,72	2821	27,66	>100000
50	2103,00	420,60	2351	23,05	>100000
40	1682,40	336,48	1880	18,44	>100000
30	1261,80	252,36	1410	13,83	>100000
20	841,20	168,24	940	9,22	>100000
10	420,60	84,12	470	4,61	>100000

Power supply (volts)	400
Phases:	three phases
Frequency (Hz)	50 Hz
Rotation speed (RPM)	1000
Max input power (watt)	3200
Max current (amp)	6,50
IS/IR	5,24

DIMENSIONAL SPECIFICATIONS (mm)

Vibrator weight: 204,0 kg

Continual service ambient temperature: -20°C à +40°C - Tropicalization anti-mold - Mechanical protection: IP66 IK08 according to IEC

Bearing type: ROLLER

Lubrication LONG-LIFE with KLUEBER STABURAGS NBU 8EP.

Re lubrication quantity after 1000 hours of using: 40g

Max quantity by replaced bearing: 80g

Fixing with 4 screws M24 - 15/16" quality 8.8 with tightening torque (kgm - ft/lb): 71 - 513

Power supply cable size: 13 à 20 mm - Cable entry thread: M32x1,5

Maintenance space: 233 mm

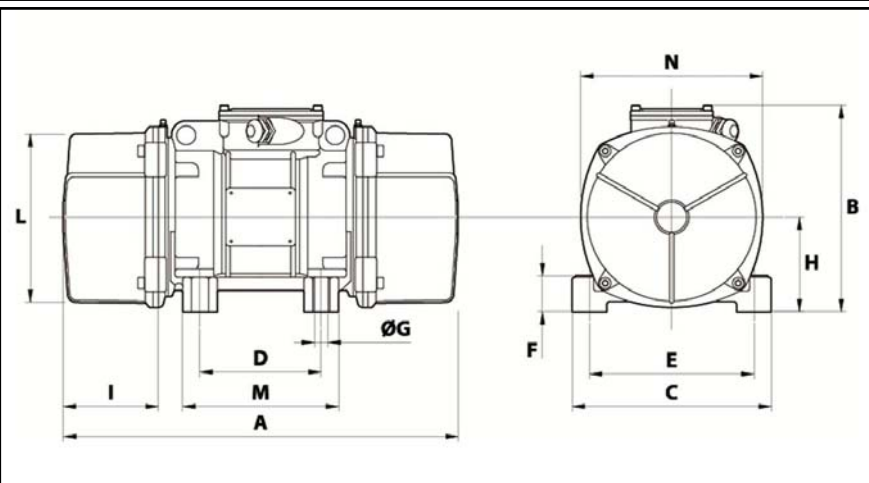

A	796
B	347
C	340
D	180
E	280
F	80
G	26
N° HOLES	4
H	165
I	233
L	303
M	240
N	320
