

ACBMV B. CASADIO VIBRATION
 Z.I. Mi-Plaine
 51 Rue Ampère
 B.P. 31
 69682 CHASSIEU CEDEX (FRANCE)
 Tel.: 04 78 90 87 87 / Fax.: 04 78 90 87 88
 Email: vibrateur@orange.fr
 Internet: acbmv.com

6 POLES - 1000 RPM ATEX II 2D tD A21 IP 66 ZONE 21-22
 REF.: 602227A Dust T°=135°C
 SIZE: 97

Certifications:



MECHANICAL AND ELECTRICAL SPECIFICATIONS

Eccentric weight setup (%)	Static moment (kgmm)	Working moment (kgcm)	Centrifugal force (kg)	Centrifugal force (kN)	Estimated bearings life time (hours)
100	11510,00	2302,00	12867	126,00	18318
90	10359,00	2071,80	11580	113,40	26028
80	9208,00	1841,60	10294	100,80	38535
70	8057,00	1611,40	9007	88,20	60145
60	6906,00	1381,20	7720	75,60	>100000
50	5755,00	1151,00	6434	63,00	>100000
40	4604,00	920,80	5147	50,40	>100000
30	3453,00	690,60	3860	37,80	>100000
20	2302,00	460,40	2573	25,20	>100000
10	1151,00	230,20	1287	12,60	>100000

Power supply (volts)	400
Phases:	three phases
Frequency (Hz)	50 Hz
Rotation speed (RPM)	1000
Max input power (watt)	9600
Max current (amp)	17,00
IS/IR	4,98

DIMENSIONAL SPECIFICATIONS (mm)

Vibrator weight: 460,0 kg

Continual service ambient temperature: -20°C à +40°C - Tropicalization anti-mold - Mechanical protection: IP66 IK08 according to IEC

Bearing type: ROLLER

Lubrication LONG-LIFE with KLUEBER STABURAGS NBU 8EP.

Re lubrication quantity after 1000 hours of using: 130g

Max quantity by replaced bearing: 260g

Fixing with 6 screws M36 - 1 3/8" quality 8.8 with tightening torque (kgm - ft/lb): 190 - 1370

Power supply cable size: 13 à 20 mm - Cable entry thread: M32x1,5

Maintenance space: 300 mm

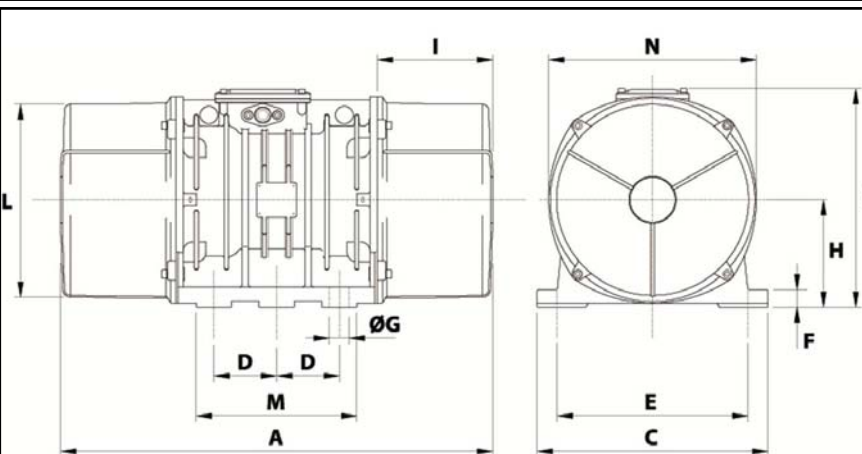

A	1002
B	437
C	460
D	125
E	380
F	35
G	39
N° HOLES	6
H	215
I	300
L	387
M	320
N	414