

ACBMV B. CASADIO VIBRATION  
 Z.I. Mi-Plaine  
 51 Rue Ampère  
 B.P. 31  
 69682 CHASSIEU CEDEX (FRANCE)  
 Tel.: 04 78 90 87 87 / Fax.: 04 78 90 87 88  
 Email: [vibrateur@orange.fr](mailto:vibrateur@orange.fr)  
 Internet: [acbmv.com](http://acbmv.com)

6 POLES - 1000 RPM      ATEX II 2D tD A21 IP 66 ZONE 21-22  
 REF.: 602296A              Dust T°=120°C  
 SIZE: 10

Certifications:



### MECHANICAL AND ELECTRICAL SPECIFICATIONS

Eccentric weight setup (%)	Static moment (kgmm)	Working moment (kgcm)	Centrifugal force (kg)	Centrifugal force (kN)	Estimated bearings life time (hours)
100	30,10	6,02	35	0,33	>100000
90	27,09	5,42	32	0,30	>100000
80	24,08	4,82	28	0,26	>100000
70	21,07	4,21	25	0,23	>100000
60	18,06	3,61	21	0,20	>100000
50	15,05	3,01	18	0,17	>100000
40	12,04	2,41	14	0,13	>100000
30	9,03	1,81	11	0,10	>100000
20	6,02	1,20	7	0,07	>100000
10	3,01	0,60	4	0,03	>100000

Power supply (volts)	400
Phases:	three phases
Frequency (Hz)	50 Hz
Rotation speed (RPM)	1000
Max input power (watt)	120
Max current (amp)	0,30
IS/IR	1,90

### DIMENSIONAL SPECIFICATIONS (mm)

**Vibrator weight: 9,7 kg**

Continual service ambient temperature: -20°C à +40°C - Tropicalization anti-mold - Mechanical protection: IP66 IK08 according to IEC

Bearing type: BALL

Lubrication "FOR LIFE" with double protection screen

Fixing with 4 screws M12 - 1/2" quality 8.8 with tightening torque (kgm - ft/lb): 8 - 58

Power supply cable size: 6.5 à 12 mm - Cable entry thread: M20x1,5

Maintenance space: 54 mm

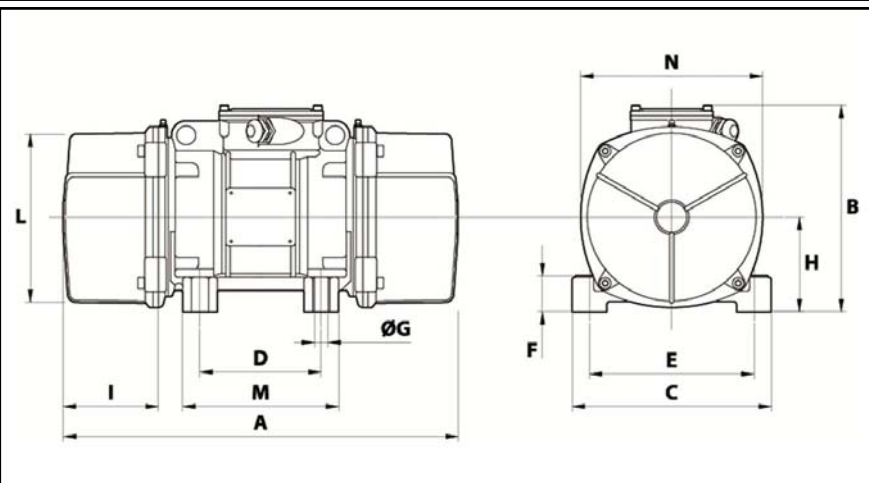

A	255
B	179
C	152
D	90
E	125
F	28
G	13
N° HOLES	4
H	73
I	54
L	127
M	128
N	141