

ACBMV B. CASADIO VIBRATION
 Z.I. Mi-Plaine
 51 Rue Ampère
 B.P. 31
 69682 CHASSIEU CEDEX (FRANCE)
 Tel.: 04 78 90 87 87 / Fax.: 04 78 90 87 88
 Email: vibrateur@orange.fr
 Internet: acbmv.com

6 POLES - 1000 RPM ATEX II 2D tD A21 IP 66 ZONE 21-22
 REF.: 602349A Dust T°=135°C
 SIZE: 97

Certifications:



MECHANICAL AND ELECTRICAL SPECIFICATIONS

Eccentric weight setup (%)	Static moment (kgmm)	Working moment (kgcm)	Centrifugal force (kg)	Centrifugal force (kN)	Estimated bearings life time (hours)
100	9983,00	1996,60	11160	109,00	11096
90	8984,70	1796,94	10044	98,10	15765
80	7986,40	1597,28	8928	87,20	23345
70	6988,10	1397,62	7812	76,30	36434
60	5989,80	1197,96	6696	65,40	60906
50	4991,50	998,30	5580	54,50	>100000
40	3993,20	798,64	4464	43,60	>100000
30	2994,90	598,98	3348	32,70	>100000
20	1996,60	399,32	2232	21,80	>100000
10	998,30	199,66	1116	10,90	>100000

Power supply (volts)	400
Phases:	three phases
Frequency (Hz)	50 Hz
Rotation speed (RPM)	1000
Max input power (watt)	7600
Max current (amp)	13,50
IS/IR	4,72

DIMENSIONAL SPECIFICATIONS (mm)

Vibrator weight: 405,0 kg

Continual service ambient temperature: -20°C à +40°C - Tropicalization anti-mold - Mechanical protection: IP66 IK08 according to IEC

Bearing type: ROLLER

Lubrication LONG-LIFE with KLUEBER STABURAGS NBU 8EP.

Re lubrication quantity after 1000 hours of using: 90g

Max quantity by replaced bearing: 180g

Fixing with 6 screws M36 - 1 3/8" quality 8.8 with tightening torque (kgm - ft/lb): 190 - 1370

Power supply cable size: 13 à 20 mm - Cable entry thread: M32x1,5

Maintenance space: 255 mm

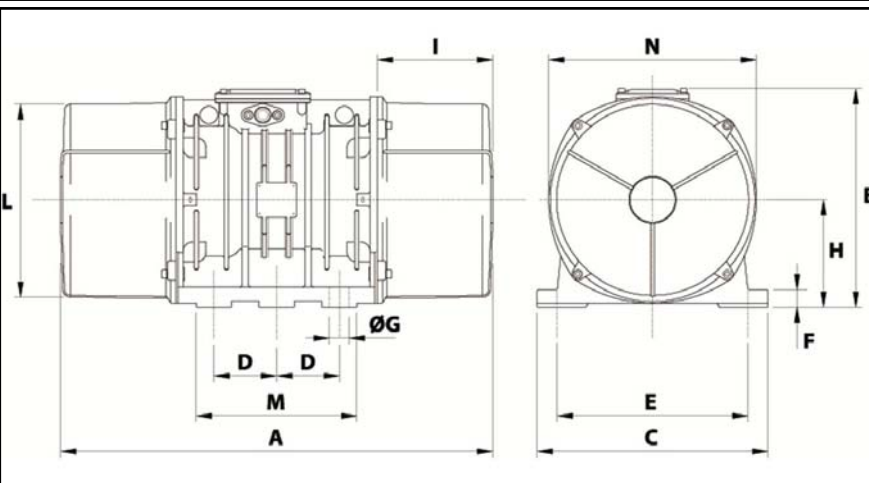

A	912
B	437
C	460
D	125
E	380
F	35
G	39
N° HOLES	6
H	215
I	255
L	387
M	320
N	414