

ACBMV B. CASADIO VIBRATION
 Z.I. Mi-Plaine
 51 Rue Ampère
 B.P. 31
 69682 CHASSIEU CEDEX (FRANCE)
 Tel.: 04 78 90 87 87 / Fax.: 04 78 90 87 88
 Email: vibrateur@orange.fr
 Internet: acbmv.com

6 POLES - 1000 RPM ATEX II 2D tD A21 IP 66 ZONE 21-22
 REF.: 602351A Dust T°=135°C
 SIZE: 90

Certifications:



MECHANICAL AND ELECTRICAL SPECIFICATIONS

Eccentric weight setup (%)	Static moment (kgmm)	Working moment (kgcm)	Centrifugal force (kg)	Centrifugal force (kN)	Estimated bearings life time (hours)
100	5044,00	1008,80	5650	55,40	23155
90	4539,60	907,92	5085	49,86	32898
80	4035,20	807,04	4520	44,32	48717
70	3530,80	706,16	3955	38,78	76030
60	3026,40	605,28	3390	33,24	>100000
50	2522,00	504,40	2825	27,70	>100000
40	2017,60	403,52	2260	22,16	>100000
30	1513,20	302,64	1695	16,62	>100000
20	1008,80	201,76	1130	11,08	>100000
10	504,40	100,88	565	5,54	>100000

Power supply (volts)	400
Phases:	three phases
Frequency (Hz)	50 Hz
Rotation speed (RPM)	1000
Max input power (watt)	3800
Max current (amp)	7,00
IS/IR	4,71

DIMENSIONAL SPECIFICATIONS (mm)

Vibrator weight: 240,0 kg

Continual service ambient temperature: -20°C à +40°C - Tropicalization anti-mold - Mechanical protection: IP66 IK08 according to IEC

Bearing type: ROLLER

Lubrication LONG-LIFE with KLUEBER STABURAGS NBU 8EP.

Re lubrication quantity after 1000 hours of using: 50g

Max quantity by replaced bearing: 100g

Fixing with 4 screws M27 - 1" quality 8.8 with tightening torque (kgm - ft/lb): 89 - 645

Power supply cable size: 13 à 20 mm - Cable entry thread: M32x1,5

Maintenance space: 240 mm

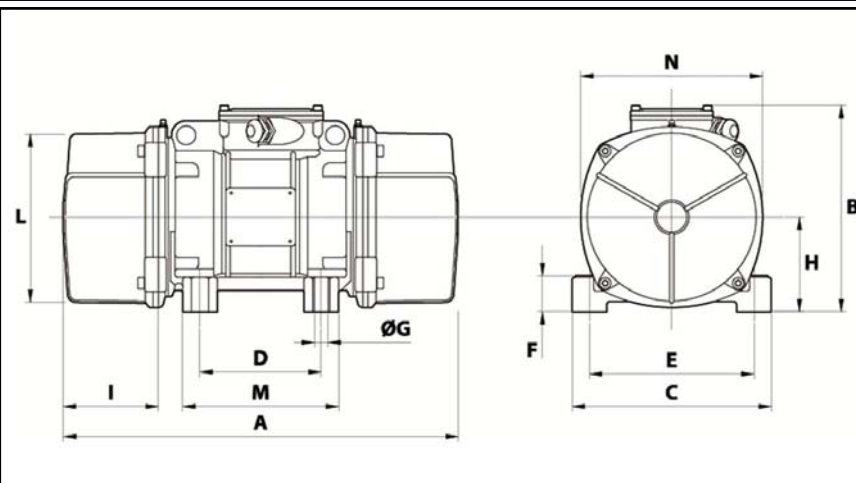

A	840
B	370
C	390
D	200
E	320
F	90
G	28
N° HOLES	4
H	180
I	240
L	330
M	270
N	350