

ACBMV B. CASADIO VIBRATION
 Z.I. Mi-Plaine
 51 Rue Ampère
 B.P. 31
 69682 CHASSIEU CEDEX (FRANCE)
 Tel.: 04 78 90 87 87 / Fax.: 04 78 90 87 88
 Email: vibrateur@orange.fr
 Internet: acbmv.com

6 POLES - 1000 RPM ATEX II 2D tD A21 IP 66 ZONE 21-22
 REF.: 602352A Dust T°=135°C
 SIZE: 90

Certifications:



MECHANICAL AND ELECTRICAL SPECIFICATIONS

Eccentric weight setup (%)	Static moment (kgmm)	Working moment (kgcm)	Centrifugal force (kg)	Centrifugal force (kN)	Estimated bearings life time (hours)
100	6272,00	1254,40	7013	68,80	20912
90	5644,80	1128,96	6312	61,92	29707
80	5017,60	1003,52	5610	55,04	44008
70	4390,40	878,08	4909	48,16	68670
60	3763,20	752,64	4208	41,28	>100000
50	3136,00	627,20	3507	34,40	>100000
40	2508,80	501,76	2805	27,52	>100000
30	1881,60	376,32	2104	20,64	>100000
20	1254,40	250,88	1403	13,76	>100000
10	627,20	125,44	701	6,88	>100000

Power supply (volts)	400
Phases:	three phases
Frequency (Hz)	50 Hz
Rotation speed (RPM)	1000
Max input power (watt)	4300
Max current (amp)	8,20
IS/IR	4,51

DIMENSIONAL SPECIFICATIONS (mm)

Vibrator weight: 275,0 kg

Continual service ambient temperature: -20°C à +40°C - Tropicalization anti-mold - Mechanical protection: IP66 IK08 according to IEC

Bearing type: ROLLER

Lubrication LONG-LIFE with KLUEBER STABURAGS NBU 8EP.

Re lubrication quantity after 1000 hours of using: 60g

Max quantity by replaced bearing: 120g

Fixing with 4 screws M27 - 1" quality 8.8 with tightening torque (kgm - ft/lb): 89 - 645

Power supply cable size: 13 à 20 mm - Cable entry thread: M32x1,5

Maintenance space: 240 mm

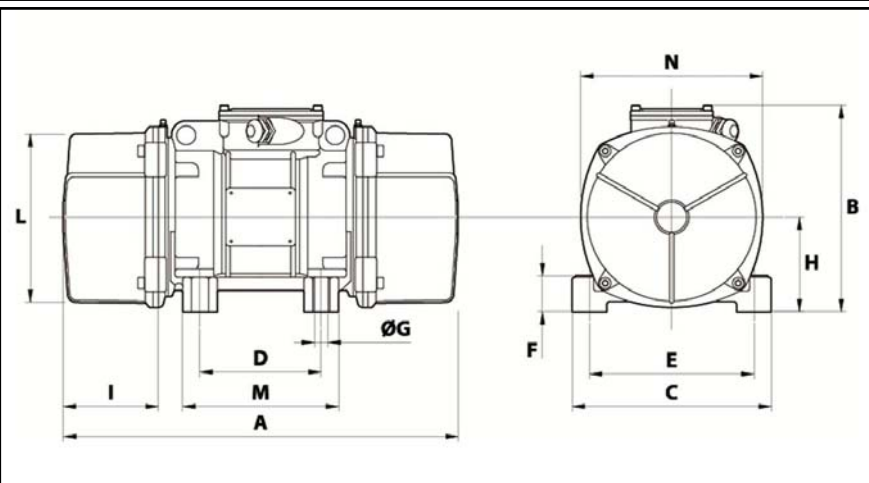

A	840
B	370
C	390
D	200
E	320
F	90
G	28
N° HOLES	4
H	180
I	240
L	330
M	270
N	350
