

ACBMV B. CASADIO VIBRATION
 Z.I. Mi-Plaine
 51 Rue Ampère
 B.P. 31
 69682 CHASSIEU CEDEX (FRANCE)
 Tel.: 04 78 90 87 87 / Fax.: 04 78 90 87 88
 Email: vibrateur@orange.fr
 Internet: acbmv.com

4 POLES - 1800 RPM ATEX II 2D tD A21 IP 66 ZONE 21-22
 REF.: 601165C Dust T°=135°C
 SIZE: 90

Certifications:



MECHANICAL AND ELECTRICAL SPECIFICATIONS

Eccentric weight setup (%)	Static moment (kgmm)	Working moment (kgcm)	Centrifugal force (kg)	Centrifugal force (kN)	Estimated bearings life time (hours)
100	1822,00	364,40	6600	64,70	14223
90	1639,80	327,96	5940	58,23	20208
80	1457,60	291,52	5280	51,76	29924
70	1275,40	255,08	4620	45,29	46702
60	1093,20	218,64	3960	38,82	78071
50	911,00	182,20	3300	32,35	>100000
40	728,80	145,76	2640	25,88	>100000
30	546,60	109,32	1980	19,41	>100000
20	364,40	72,88	1320	12,94	>100000
10	182,20	36,44	660	6,47	>100000

Power supply (volts)	460
Phases:	three phases
Frequency (Hz)	60 Hz
Rotation speed (RPM)	1800
Max input power (watt)	6000
Max current (amp)	9,00
IS/IR	7,67

DIMENSIONAL SPECIFICATIONS (mm)

Vibrator weight: 195,0 kg

Continual service ambient temperature: -20°C à +40°C - Tropicalization anti-mold - Mechanical protection: IP66 IK08 according to IEC
 Bearing type: ROLLER
 Lubrication LONG-LIFE with KLUEBER STABURAGS NBU 8EP.
 Re lubrication quantity after 1000 hours of using: 60g
 Max quantity by replaced bearing: 120g
 Fixing with 4 screws M27 - 1" quality 8.8 with tightening torque (kgm - ft/lb): 89 - 645
 Power supply cable size: 13 à 20 mm - Cable entry thread: M32x1,5
 Maintenance space: 160 mm

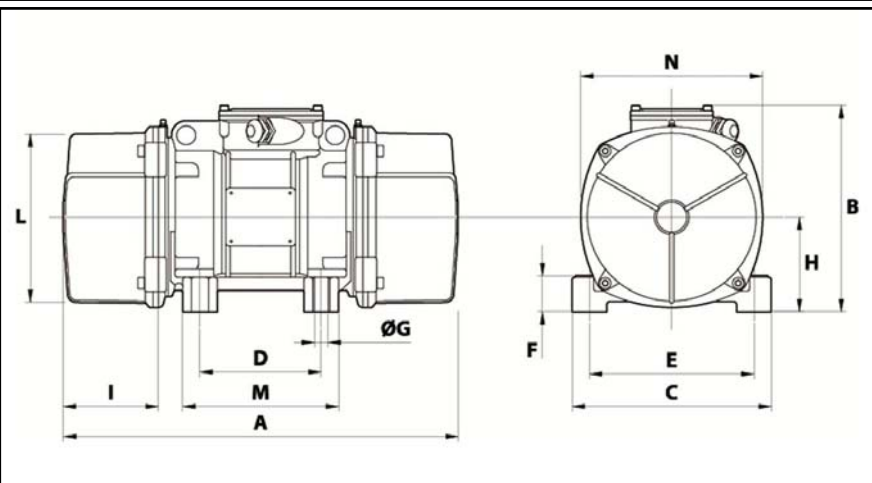

A	680
B	370
C	390
D	200
E	320
F	90
G	28
N° HOLES	4
H	180
I	160
L	330
M	270
N	350
