

ACBMV B. CASADIO VIBRATION
 Z.I. Mi-Plaine
 51 Rue Ampère
 B.P. 31
 69682 CHASSIEU CEDEX (FRANCE)
 Tel.: 04 78 90 87 87 / Fax.: 04 78 90 87 88
 Email: vibrateur@orange.fr
 Internet: acbmv.com

4 POLES - 1500 RPM ATEX II 2D tD A21 IP 66 ZONE 21-22
 REF.: 601204A Dust T°=135°C
 SIZE: 97

Certifications:



MECHANICAL AND ELECTRICAL SPECIFICATIONS

Eccentric weight setup (%)	Static moment (kgmm)	Working moment (kgcm)	Centrifugal force (kg)	Centrifugal force (kN)	Estimated bearings life time (hours)
100	3346,00	669,20	8416	82,60	18942
90	3011,40	602,28	7574	74,34	26917
80	2676,80	535,36	6733	66,08	39849
70	2342,20	468,44	5891	57,82	62204
60	2007,60	401,52	5050	49,56	>100000
50	1673,00	334,60	4208	41,30	>100000
40	1338,40	267,68	3366	33,04	>100000
30	1003,80	200,76	2525	24,78	>100000
20	669,20	133,84	1683	16,52	>100000
10	334,60	66,92	842	8,26	>100000

Power supply (volts)	400
Phases:	three phases
Frequency (Hz)	50 Hz
Rotation speed (RPM)	1500
Max input power (watt)	7500
Max current (amp)	12,20
IS/IR	6,56

DIMENSIONAL SPECIFICATIONS (mm)

Vibrator weight: 317,0 kg

Continual service ambient temperature: -20°C à +40°C - Tropicalization anti-mold - Mechanical protection: IP66 IK08 according to IEC

Bearing type: ROLLER

Lubrication LONG-LIFE with KLUEBER STABURAGS NBU 8EP.

Re lubrication quantity after 1000 hours of using: 90g

Max quantity by replaced bearing: 180g

Fixing with 6 screws M36 - 1 3/8" quality 8.8 with tightening torque (kgm - ft/lb): 190 - 1370

Power supply cable size: 13 à 20 mm - Cable entry thread: M32x1,5

Maintenance space: 230 mm

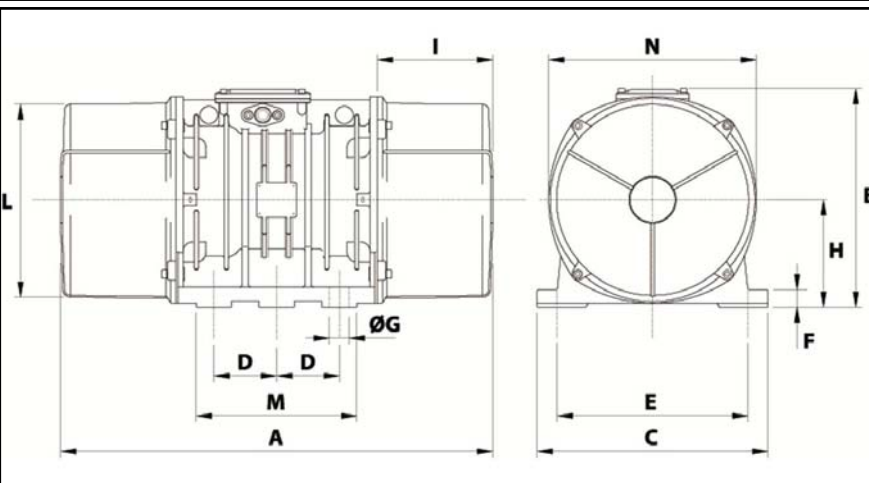

A	862
B	437
C	460
D	125
E	380
F	35
G	39
N° HOLES	6
H	215
I	230
L	387
M	320
N	414