

ACBMV B. CASADIO VIBRATION
 Z.I. Mi-Plaine
 51 Rue Ampère
 B.P. 31
 69682 CHASSIEU CEDEX (FRANCE)
 Tel.: 04 78 90 87 87 / Fax.: 04 78 90 87 88
 Email: vibrateur@orange.fr
 Internet: acbmv.com

4 POLES - 1800 RPM ATEX II 2D tD A21 IP 66 ZONE 21-22
 REF.: 601204C Dust T°=135°C
 SIZE: 97

Certifications:



MECHANICAL AND ELECTRICAL SPECIFICATIONS

Eccentric weight setup (%)	Static moment (kgmm)	Working moment (kgcm)	Centrifugal force (kg)	Centrifugal force (kN)	Estimated bearings life time (hours)
100	2462,00	492,40	8916	87,50	13023
90	2215,80	443,16	8024	78,75	18506
80	1969,60	393,92	7133	70,00	27397
70	1723,40	344,68	6241	61,25	42766
60	1477,20	295,44	5350	52,50	71466
50	1231,00	246,20	4458	43,75	>100000
40	984,80	196,96	3566	35,00	>100000
30	738,60	147,72	2675	26,25	>100000
20	492,40	98,48	1783	17,50	>100000
10	246,20	49,24	892	8,75	>100000

Power supply (volts)	460
Phases:	three phases
Frequency (Hz)	60 Hz
Rotation speed (RPM)	1800
Max input power (watt)	8500
Max current (amp)	12,00
IS/IR	6,67

DIMENSIONAL SPECIFICATIONS (mm)

Vibrator weight: 303,0 kg

Continual service ambient temperature: -20°C à +40°C - Tropicalization anti-mold - Mechanical protection: IP66 IK08 according to IEC

Bearing type: ROLLER

Lubrication LONG-LIFE with KLUEBER STABURAGS NBU 8EP.

Re lubrication quantity after 1000 hours of using: 90g

Max quantity by replaced bearing: 180g

Fixing with 6 screws M36 - 1 3/8" quality 8.8 with tightening torque (kgm - ft/lb): 190 - 1370

Power supply cable size: 13 à 20 mm - Cable entry thread: M32x1,5

Maintenance space: 230 mm

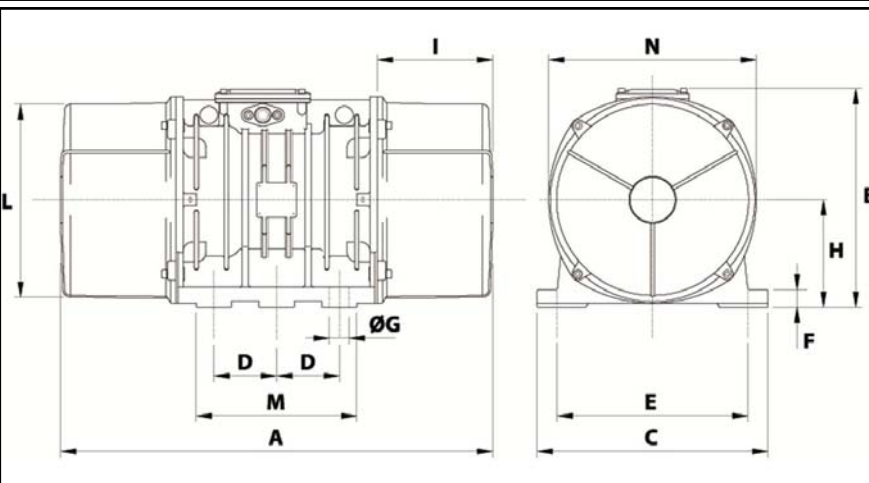

A	862
B	437
C	460
D	125
E	380
F	35
G	39
N° HOLES	6
H	215
I	230
L	387
M	320
N	414