

ACBMV B. CASADIO VIBRATION
 Z.I. Mi-Plaine
 51 Rue Ampère
 B.P. 31
 69682 CHASSIEU CEDEX (FRANCE)
 Tel.: 04 78 90 87 87 / Fax.: 04 78 90 87 88
 Email: vibrateur@orange.fr
 Internet: acbmv.com

4 POLES - 1800 RPM ATEX II 2D tD A21 IP 66 ZONE 21-22
 REF.: 601221C Dust T°=135°C
 SIZE: 70

Certifications:



MECHANICAL AND ELECTRICAL SPECIFICATIONS

Eccentric weight setup (%)	Static moment (kgmm)	Working moment (kgcm)	Centrifugal force (kg)	Centrifugal force (kN)	Estimated bearings life time (hours)
100	1034,00	206,80	3744	36,70	18170
90	930,60	186,12	3370	33,03	25805
80	827,20	165,44	2995	29,36	38237
70	723,80	144,76	2621	25,69	59646
60	620,40	124,08	2246	22,02	99795
50	517,00	103,40	1872	18,35	>100000
40	413,60	82,72	1498	14,68	>100000
30	310,20	62,04	1123	11,01	>100000
20	206,80	41,36	749	7,34	>100000
10	103,40	20,68	374	3,67	>100000

Power supply (volts)	460
Phases:	three phases
Frequency (Hz)	60 Hz
Rotation speed (RPM)	1800
Max input power (watt)	2500
Max current (amp)	3,90
IS/IR	6,92

DIMENSIONAL SPECIFICATIONS (mm)

Vibrator weight: 110,0 kg

Continual service ambient temperature: -20°C à +40°C - Tropicalization anti-mold - Mechanical protection: IP66 IK08 according to IEC

Bearing type: ROLLER

Lubrication LONG-LIFE with KLUEBER STABURAGS NBU 8EP.

Re lubrication quantity after 1000 hours of using: 26g

Max quantity by replaced bearing: 40g

Fixing with 4 screws M22 - 7/8" quality 8.8 with tightening torque (kgm - ft/lb): 56 - 411

Power supply cable size: 9 à 16 mm - Cable entry thread: M25x1,5

Maintenance space: 137 mm

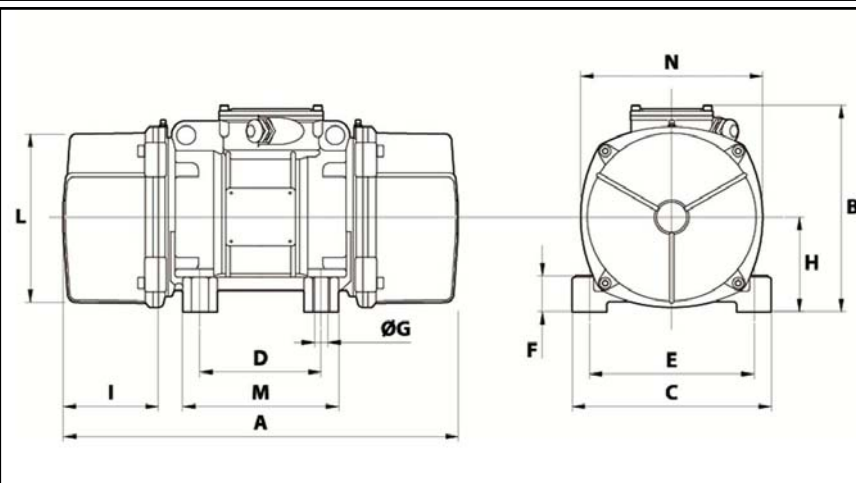

A	584
B	321
C	310
D	155
E	255
F	77
G	24
N° HOLES	4
H	157
I	137
L	277
M	215
N	295