

ACBMV B. CASADIO VIBRATION
 Z.I. Mi-Plaine
 51 Rue Ampère
 B.P. 31
 69682 CHASSIEU CEDEX (FRANCE)
 Tel.: 04 78 90 87 87 / Fax.: 04 78 90 87 88
 Email: vibrateur@orange.fr
 Internet: acbmv.com

4 POLES - 1500 RPM
 REF.: 601349A
 SIZE: 40

Certifications:



MECHANICAL AND ELECTRICAL SPECIFICATIONS

Eccentric weight setup (%)	Static moment (kgmm)	Working moment (kgcm)	Centrifugal force (kg)	Centrifugal force (kN)	Estimated bearings life time (hours)
100	561	112,20	1413	13,90	17170
90	504,90	100,98	1272	12,51	24376
80	448,80	89,76	1130	11,12	36167
70	392,70	78,54	989	9,73	56397
60	336,60	67,32	848	8,34	94173
50	280,50	56,10	707	6,95	>100000
40	224,40	44,88	565	5,56	>100000
30	168,30	33,66	424	4,17	>100000
20	112,20	22,44	283	2,78	>100000
10	56,10	11,22	141	1,39	>100000

Power supply (volts)	400
Phases:	three phases
Frequency (Hz)	50 Hz
Rotation speed (RPM)	1500
Max input power (watt)	900
Max current (amp)	1,45
IS/IR	4,2

DIMENSIONAL SPECIFICATIONS (mm)

Vibrator weight: 53 kg

Continual service ambient temperature: -20°C à +40°C - Tropicalization anti-mold - Mechanical protection: IP66 IK08 according to IEC

Bearing type: ROLLER

Lubrication LONG-LIFE with KLUEBER STABURAGS NBU 8EP.

Re lubrication quantity after 1000 hours of using: 9g

Max quantity by replaced bearing: 16g

Fixing with 4 screws M16 - 5/8" quality 8.8 with tightening torque (kgm - ft/lb): 19 - 137

Power supply cable size: 9 à 16 mm - Cable entry thread: M25x1,5

Maintenance space: 105 mm

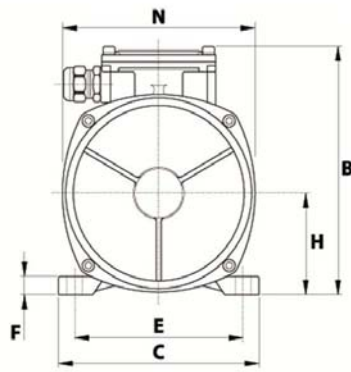
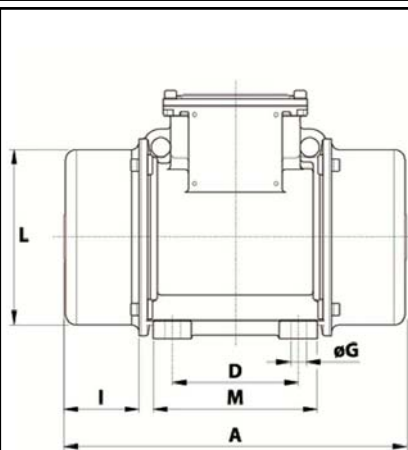

A	442
B	245
C	230
D	140
E	190
F	25
G	17
N° HOLES	4
H	116
I	105
L	201
M	180
N	225-

--	--	--	--	--	--