

ACBMV B. CASADIO VIBRATION
 Z.I. Mi-Plaine
 51 Rue Ampère
 B.P. 31
 69682 CHASSIEU CEDEX (FRANCE)
 Tel.: 04 78 90 87 87 / Fax.: 04 78 90 87 88
 Email: vibrateur@orange.fr
 Internet: acbmv.com

4 POLES - 1500 RPM ATEX II 2D tD A21 IP 66 ZONE 21-22
 REF.: 601372A Dust T°=120°C
 SIZE: 20

Certifications:



MECHANICAL AND ELECTRICAL SPECIFICATIONS

Eccentric weight setup (%)	Static moment (kgmm)	Working moment (kgcm)	Centrifugal force (kg)	Centrifugal force (kN)	Estimated bearings life time (hours)
100	163,00	32,60	412	4,04	15922
90	146,70	29,34	371	3,64	21806
80	130,40	26,08	330	3,23	30985
70	114,10	22,82	288	2,83	46614
60	97,80	19,56	247	2,42	73892
50	81,50	16,30	206	2,02	>100000
40	65,20	13,04	165	1,62	>100000
30	48,90	9,78	124	1,21	>100000
20	32,60	6,52	82	0,81	>100000
10	16,30	3,26	41	0,40	>100000

Power supply (volts)	400
Phases:	three phases
Frequency (Hz)	50 Hz
Rotation speed (RPM)	1500
Max input power (watt)	300
Max current (amp)	0,60
IS/IR	3,33

DIMENSIONAL SPECIFICATIONS (mm)

Vibrator weight: 19,0 kg

Continual service ambient temperature: -20°C à +40°C - Tropicalization anti-mold - Mechanical protection: IP66 IK08 according to IEC

Bearing type: BALL

Lubrication "FOR LIFE" with double protection screen

Fixing with 4 screws M12 - 1/2" quality 8.8 with tightening torque (kgm - ft/lb): 8 - 58

Power supply cable size: 9 à 16 mm - Cable entry thread: M25x1,5

Maintenance space: 93 mm

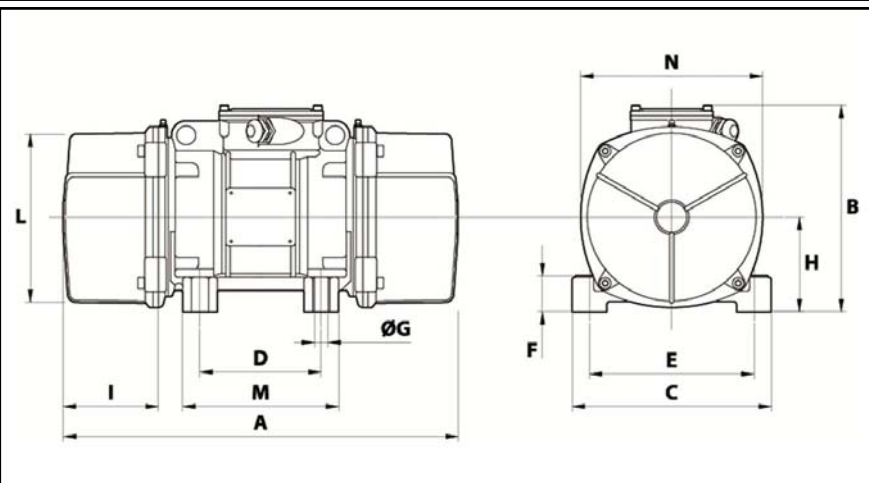

A	344
B	203
C	167
D	105
E	140
F	30
G	13
N° HOLES	4
H	83
I	93
L	145
M	140
N	160