

ACBMV B. CASADIO VIBRATION  
 Z.I. Mi-Plaine  
 51 Rue Ampère  
 B.P. 31  
 69682 CHASSIEU CEDEX (FRANCE)  
 Tel.: 04 78 90 87 87 / Fax.: 04 78 90 87 88  
 Email: [vibrateur@orange.fr](mailto:vibrateur@orange.fr)  
 Internet: [acbmv.com](http://acbmv.com)

4 POLES - 1800 RPM      ATEX II 2D tD A21 IP 66 ZONE 21-22  
 REF.: 601408C              Dust T°=120°C  
 SIZE: 30

Certifications:



### MECHANICAL AND ELECTRICAL SPECIFICATIONS

Eccentric weight setup (%)	Static moment (kgmm)	Working moment (kgcm)	Centrifugal force (kg)	Centrifugal force (kN)	Estimated bearings life time (hours)
100	209,00	41,80	760	7,46	13784
90	188,10	37,62	684	6,71	18908
80	167,20	33,44	608	5,97	26922
70	146,30	29,26	532	5,22	40187
60	125,40	25,08	456	4,48	63815
50	104,50	20,90	380	3,73	>100000
40	83,60	16,72	304	2,98	>100000
30	62,70	12,54	228	2,24	>100000
20	41,80	8,36	152	1,49	>100000
10	20,90	4,18	76	0,75	>100000

Power supply (volts)	460
Phases:	three phases
Frequency (Hz)	60 Hz
Rotation speed (RPM)	1800
Max input power (watt)	665
Max current (amp)	0,98
IS/IR	3,43

### DIMENSIONAL SPECIFICATIONS (mm)

**Vibrator weight: 26,2 kg**

Continual service ambient temperature: -20°C à +40°C - Tropicalization anti-mold - Mechanical protection: IP66 IK08 according to IEC

Bearing type: BALL

Lubrication "FOR LIFE" with double protection screen

Fixing with 4 screws M16 - 5/8" quality 8.8 with tightening torque (kgm - ft/lb): 19 - 137

Power supply cable size: 9 à 16 mm - Cable entry thread: M25x1,5

Maintenance space: 106 mm

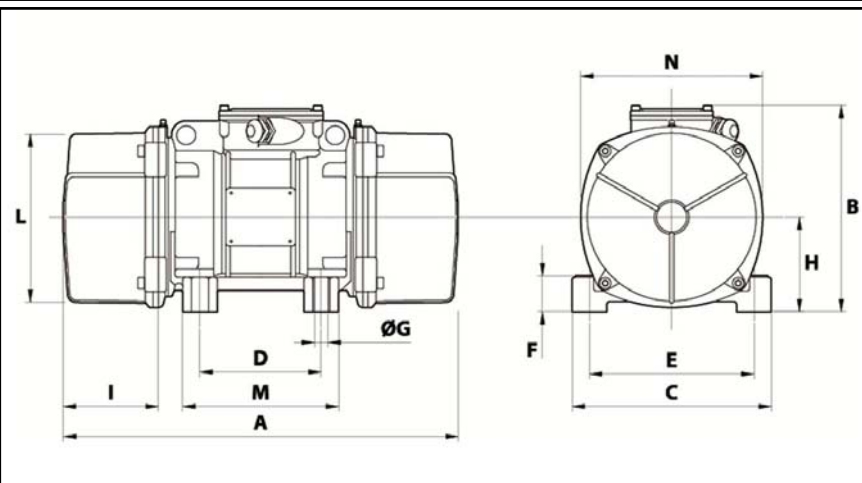

A	394
B	216
C	205
D	120
E	170
F	45
G	17
N° HOLES	4
H	94
I	106
L	170
M	160
N	182