

ACBMV B. CASADIO VIBRATION
 Z.I. Mi-Plaine
 51 Rue Ampère
 B.P. 31
 69682 CHASSIEU CEDEX (FRANCE)
 Tel.: 04 78 90 87 87 / Fax.: 04 78 90 87 88
 Email: vibrateur@orange.fr
 Internet: acbmv.com

8 POLES - 750 RPM
 REF.: 602620A
 SIZE: 40

Certifications:



MECHANICAL AND ELECTRICAL SPECIFICATIONS

Eccentric weight setup (%)	Static moment (kgmm)	Working moment (kgcm)	Centrifugal force (kg)	Centrifugal force (kN)	Estimated bearings life time (hours)
100	723	144,60	456	4,47	>100000
90	650,70	130,14	410	4,02	>100000
80	578,40	115,68	365	3,58	>100000
70	506,10	101,22	319	3,13	>100000
60	433,80	86,76	274	2,68	>100000
50	361,50	72,30	228	2,24	>100000
40	289,20	57,84	182	1,79	>100000
30	216,90	43,38	137	1,34	>100000
20	144,60	28,92	91	0,89	>100000
10	72,30	14,46	46	0,45	>100000

Power supply (volts)	400
Phases:	three phases
Frequency (Hz)	50 Hz
Rotation speed (RPM)	750
Max input power (watt)	400
Max current (amp)	1,2
IS/IR	2,58

DIMENSIONAL SPECIFICATIONS (mm)

Vibrator weight: 54 kg

Continual service ambient temperature: -20°C à +40°C - Tropicalization anti-mold - Mechanical protection: IP66 IK08 according to IEC

Bearing type: BALL

Lubrication "FOR LIFE" with double protection screen

Fixing with 4 screws M16 - 5/8" quality 8.8 with tightening torque (kgm - ft/lb): 19 - 137

Power supply cable size: 9 à 16 mm - Cable entry thread: M25x1,5

Maintenance space: 129 mm

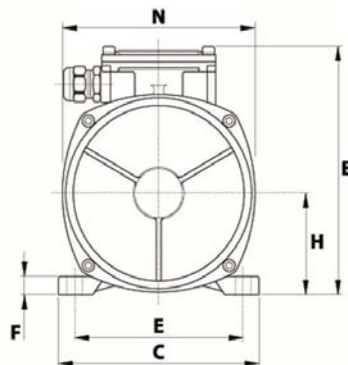

A	490
B	245
C	230
D	140
E	190
F	25
G	17
N° HOLES	4
H	116
I	129
L	201
M	180
N	225
