

Turbine vibrator type GT30

ACBMV B. CASADIO VIBRATION
 Z.I. Mi-Plaine
 51 Rue Ampère
 B.P. 31
 69682 CHASSIEU CEDEX (FRANCE)
 Tel.: 04 78 90 87 87 / Fax.: 04 78 90 87 88
 Email: vibrateur@orange.fr
 Internet: acbmv.com

Description:
 High speed and eccentric working torques for strong vibration. Wide range.

VIBRATING AND PNEUMATIC CHARACTERISTICS

	2 Bars/29 PSI	4 Bars/58 PSI	6 Bars/87 PSI
Frequency (RPM)	13000	14000	16000
Force (N)	3380	5430	7540
Force (LBS)	761,26	1222,97	1698,20
Air cons. (l/min)	330	530	745
Air cons. (CF)	11,79	18,93	26,61

Typical applications:

- Bunker emptying
- Screen filter
- Vibrating tables
- Preventing adhesions in pipelines and silos
- Moving of bulk materials

Construction:

- Vibration from the centrifugal force of positive and negative unbalanced torques in the rotor.
- Rotor on two pre-lubricated and enclosed ball bearings arranged in pairs. Lubricated with special grease for long life.

Properties:

- Lubrication free
- Extremely quiet
- Strong vibration from high speeds and eccentric working torques
- Nominal frequency 13000 à 16000 RPM
- Centrifugal force 3380 – 7540 N
- Continuously variable (compressed air)
- Can be used at temperatures up to 150°C
- Resistant to extreme environmental conditions



Design:

- 1 Housing made from extruded aluminium alloy
 - 2 Turbine wheel made from surface-hardened aluminium
 - 3-4 high-density inserts: positive torque
 - 5-7 openings for achieving negative torque
 - 8 Air supply
 - 9 Air outlet
 - 10 Base mounting bores
 - 11 Pre-lubricated and enclosed ball bearings arranged in pairs
- Surface-hardened aluminium end plates
 12 with left-hand thread
 13 with right-hand thread

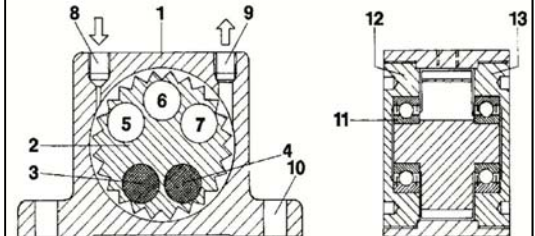

DIMENSIONAL SPECIFICATIONS

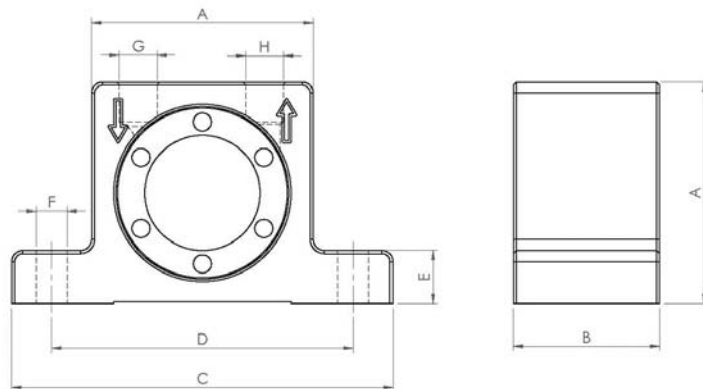

	mm	inch
A	100	3,94
B	73	2,88
C	160	6,30
D	130	5,12
E	20	0,79
F	11	0,43
G	G 3/8"	G 3/8"
H	G 3/8"	G 3/8"
	kg	LBS
Vibrator weight	2,2	4,889